

Centro (V2)

Inline centrifugal fans

Use

- Supply and extract ventilation systems installed in various premises.
- Mounting in kitchens, bathrooms and other humid premises.
- Compatible with Ø 100 up to 315 mm round air ducts.



Air flow:
up to 1700 m³/h
472 l/s



Power:
from 45 W



Noise level:
from 36 dBA



Design

- High-quality durable plastic casing.
- Aerodynamically shaped casing.
- Airtight mounting box.
- Centro 150** is compatible with 150 and 160 mm air ducts.

Motor

- Single-phase external rotor motor with a centrifugal impeller with backward curved blades.
- Equipped with ball bearings for longer service life.
- Integrated thermal protection with automatic restart.
- Dynamically balanced impeller.
- Some standard sizes have high-powered motors (**Centro max**).
- For ventilation of premises with high requirements to noise level low-noise modifications are available (**Centro L**).
- Centro V2** serie impellers: two-speed asynchronous motor with external rotor and centrifugal impeller with forward curved blades.

Speed control

- Smooth speed control with a built-in electronic speed controller (option **FR**).
- Smooth speed control with an external thyristor controller or step speed control with an external auto transformer (both available upon separate order).
- Centro V2** series: Two-speed control with the external CDP-2/5 or CDP-2/10 speed switch (available upon separate order).

Mounting

- Due to compact design the fan is the ideal solution for mounting in limited spaces.
- Any mounting position.
- Wall or ceiling mounting with fixing brackets supplied as a standard or with a wire frame **Halter Centro** (available upon separate order).
- Flexible air ducts are fixed on the fan spigots with clamps.



Modifications and options

- max:** high-powered motor.
- L:** low-powered and low-noise motor.
- FR:** smooth speed controller adjustable from 0 to 100 % and power cable with IEC C14 plug or mains plug (**FR1**).



- G:** speed controller, temperature controller with external temperature sensor (cable length 4 m), power cable with IEC C14 plug or mains plug (**G1**).
- GI:** speed controller, temperature controller with integrated temperature sensor and power cable with IEC C14 plug or mains plug (**GI1**). The **G** and **GI** modifications enable automatic speed control depending on indoor temperature. The optimal ventilation solution for premises requiring permanent temperature control as greenhouses, orangeries, etc.



- V:** built-in speed switch (for two-speed models).
- W:** the fan is equipped with a pre-wired power cable and IEC plug as a standard. Modification with a standard electric plug is available (**W1**).

Accessories

Silencer



SD

Filter boxes



KFBK / KFBT

Electric heater



EKH

Water heater



WKH

Backdraft air damper



VRV

Air dampers



VK / VKA

Speed controllers



CDT E1.8 / CDP-2/5(10)

Designation key			
Series	Duct diameter [mm]	Motor modifications	Options
Centro	100; 125; 150*; 200; 250; 315	max : high-powered motor L : low-powered motor V2 : two-speed motor	FR : smooth speed controller adjustable from 0 to 100 % and power cable with IEC C14 plug FR1 : smooth speed controller adjustable from 0 to 100 % and power cable with mains plug G : speed controller, temperature controller with external temperature sensor, power cable with IEC C14 plug G1 : speed controller, temperature controller with external temperature sensor, power cable with mains plug G1 : speed controller, temperature controller with integrated temperature sensor and power cable with IEC C14 plug G11 : speed controller, temperature controller with integrated temperature sensor and power cable mains plug V : built-in speed switch (for two-speed models) W : power cable with IEC C14 plug W1 : power cable with mains plug

* Centro 150 (V2) model is compatible with the air ducts both \varnothing 150 and 160 mm

Overall dimensions [mm]

Type	\varnothing D	\varnothing D1	B	L	L1	L2	L3	Weight [kg]
Centro 100 L / Centro 100 / Centro 100 V2	100	250	270	230	30	27	30	2.22
Centro 125 L / Centro 125 / Centro 125 V2	125	250	270	220	30	27	30	2.20
Centro 150 / Centro 150 V2	150/160	300	310	286	30	30	30	2.45
Centro 200 Centro 200 max / Centro 200 V2	200	340	354	276	30	30	40	3.00
Centro 250 L / Centro 250 / Centro 250 V2	250	340	354	265	30	30	40	4.30
Centro 315 / Centro 315 V2	315	400	414	276	40	55	40	4.85
Centro 315 max / Centro 315 max V2	315	400	414	276	40	55	40	4.85

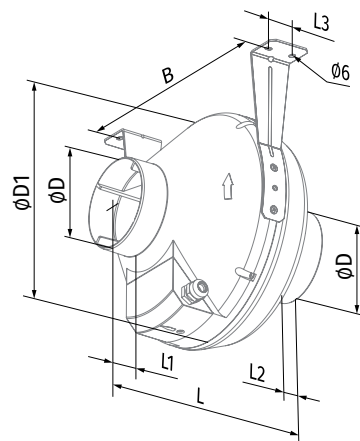

Technical data

Parameters	Centro 100 L		Centro 100		Centro 125 L		Centro 125	
Voltage [V]	1 ~ 230		1 ~ 230		1 ~ 230		1 ~ 230	
Frequency [Hz]	50	60	50	60	50	60	50	60
Power [W]	62	63	80	81	61	64	79	81
Current [A]	0,38	0,38	0,34	0,34	0,38	0,4	0,34	0,35
Maximum air flow [m³/h (l/s)]	205 (57)	210 (58)	250 (69)	290 (81)	260 (72)	270 (75)	355 (99)	370 (103)
RPM [min ⁻¹]	2650	2710	2820	2890	2610	2680	2800	2830
Sound pressure at 3 m [dBA]	36	36	40	41	36	37	40	41
Max. transported air temperature [°C]	-25...+55	-25...+50	-25...+55	-25...+50	-25...+55	-25...+50	-25...+55	-25...+50
SEC class	C	-	C	-	C	-	B	-
IP rating	IPX4		IPX4		IPX4		IPX4	
Motor IP rating	IP44		IP44		IP44		IP44	
ErP	2018		2018		2018		2018	

CENTRO 100 L, CENTRO 100

Sound power level, A-weighted	Octave frequency bands [Hz]								LpA 3 m [dBA]	LpA 1 m [dBA]	
	Total	63	125	250	500	1000	2000	4000			8000
Centro 100 L											
LWA to inlet [dBA]	77	55	69	75	67	62	58	52	42	56	66
LWA to outlet [dBA]	76	62	69	74	66	59	55	51	40	55	65
LWA to environment [dBA]	57	26	45	47	51	52	49	40	31	36	46
Centro 100											
LWA to inlet [dBA]	83	60	75	81	73	67	63	57	46	62	72
LWA to outlet [dBA]	82	67	75	80	72	64	60	55	44	61	71
LWA to environment [dBA]	61	28	49	51	55	57	53	44	34	40	50

CENTRO 125 L, CENTRO 125

Sound power level, A-weighted	Octave frequency bands [Hz]								LpA 3 m [dBA]	LpA 1 m [dBA]	
	Total	63	125	250	500	1000	2000	4000			8000
Centro 125 L											
LWA to inlet [dBA]	78	52	70	76	67	63	60	55	46	57	67
LWA to outlet [dBA]	77	59	70	75	66	60	58	53	45	56	66
LWA to environment [dBA]	56	27	40	48	51	50	50	40	28	36	46
Centro 125											
LWA to inlet [dBA]	84	56	76	82	72	68	65	59	50	63	73
LWA to outlet [dBA]	83	63	76	81	71	65	62	57	49	62	72
LWA to environment [dBA]	60	29	44	52	55	54	54	44	31	40	50

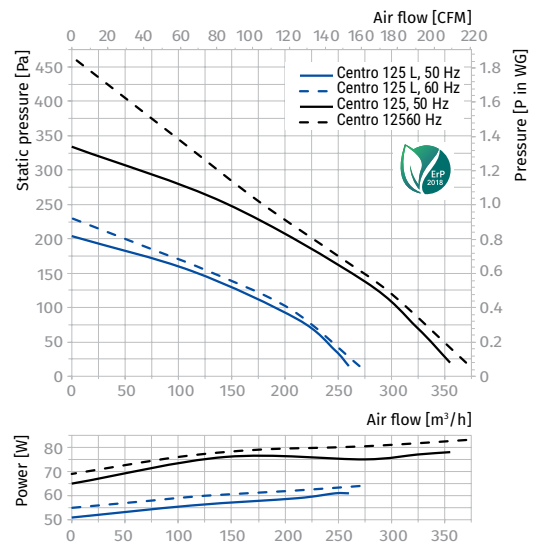
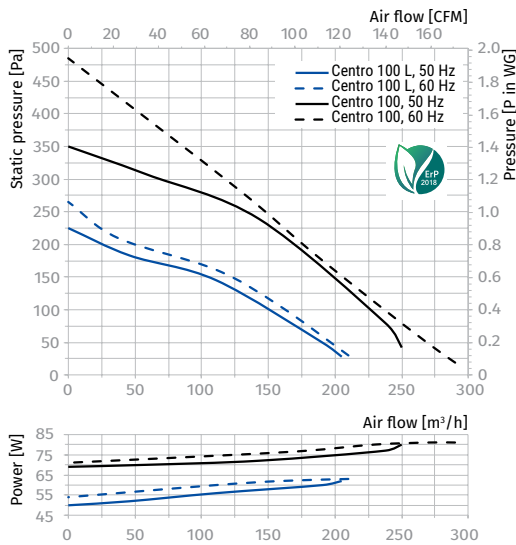

INLINE FANS

Parameters	Centro 150		Centro 200		Centro 200 max	
Voltage [V]	1 ~ 230		1 ~ 230		1 ~ 230	
Frequency [Hz]	50	60	50	60	50	60
Power [W]	80	84	107	132	173	216
Current [A]	0,35	0,37	0,47	0,58	0,76	0,94
Maximum air flow [m³/h (l/s)]	460 (128)	505 (140)	780 (217)	890 (247)	930 (258)	1020 (283)
RPM [min ⁻¹]	2725	2840	2660	2765	2125	2155
Sound pressure at 3 m [dBA]	42	43	46	46	48	49
Max. transported air temperature [°C]	-25...+55	-25...+50	-25...+55	-25...+50	-25...+55	-25...+45
SEC class	B	-	B	-	B	-
IP rating	IPX4		IPX4		IPX4	
Motor IP rating	IP44		IP44		IP44	
ErP	2018		2018		2018	

CENTRO 150

Sound power level, A-weighted	Octave frequency bands [Hz]									LpA 3 m [dBA]	LpA 1 m [dBA]
	Total	63	125	250	500	1000	2000	4000	8000		
LWA to inlet [dBA]	90	53	87	86	75	74	71	68	54	69	79
LWA to outlet [dBA]	90	53	88	85	72	71	66	65	52	69	79
LWA to environment [dBA]	63	26	46	55	57	57	57	47	35	42	52

CENTRO 200, CENTRO 200 MAX

Sound power level, A-weighted	Octave frequency bands [Hz]									LpA 3 m [dBA]	LpA 1 m [dBA]	
	Total	63	125	250	500	1000	2000	4000	8000			
Centro 200												
LWA to inlet [dBA]	85	47	74	81	77	77	78	70	59	65	75	
LWA to outlet [dBA]	83	44	73	77	75	75	78	70	60	63	73	
LWA to environment [dBA]	66	27	48	59	61	61	59	51	39	46	56	
Centro 200 max												
LWA to inlet [dBA]	90	49	78	87	81	81	82	74	63	69	79	
LWA to outlet [dBA]	87	46	77	81	79	79	82	74	64	67	77	
LWA to environment [dBA]	68	29	52	60	63	63	62	53	39	48	58	

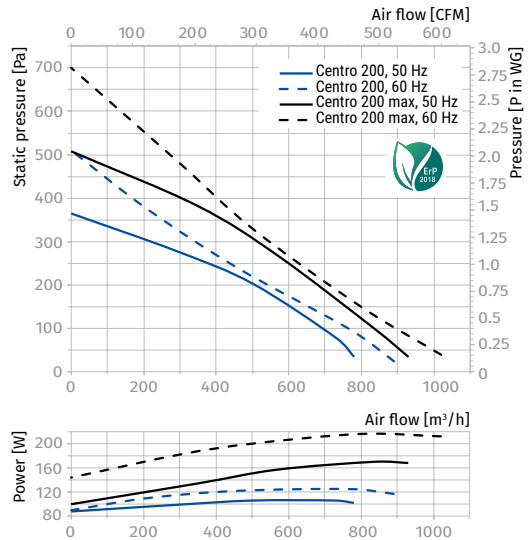
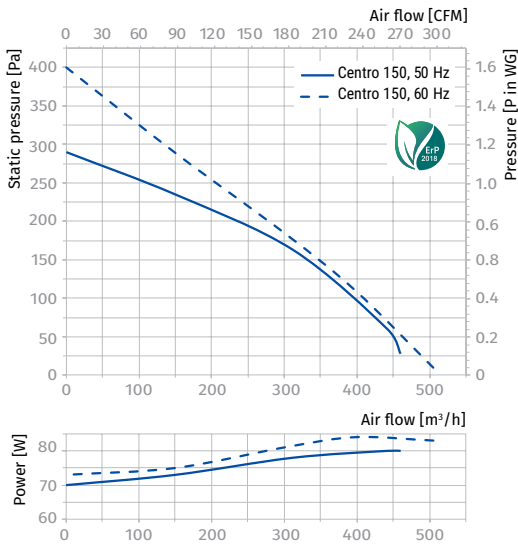

INLINE FANS

Parameters	Centro 250 L		Centro 250		Centro 315		Centro 315 max	
Voltage [V]	1 ~ 230		1 ~ 230		1 ~ 230		1 ~ 230	
Frequency [Hz]	50	60	50	60	50	60	50	60
Power [W]	108	135	173	207	200	250	310	370
Current [A]	0,47	0,59	0,76	0,9	0,88	1,1	1,36	1,65
Maximum air flow [m ³ /h (l/s)]	865 (240)	930 (258)	1080 (300)	1090 (303)	1340 (372)	1350 (375)	1700 (472)	1710 (475)
RPM [min ⁻¹]	2560	2570	2090	2120	2655	2665	2590	2600
Sound pressure at 3 m [dBA]	47	48	49	50	48	49	57	58
Max. transported air temperature [°C]	-25...+55		-25...+50		-25...+55		-25...+45	
SEC class	B	-	B	-	-	-	-	-
IP rating	IPX4		IPX4		IPX4		IPX4	
Motor IP rating	IP44		IP44		IP44		IP44	
ErP	2018		2018		2018		2018	

CENTRO 250 L, CENTRO 250

Sound power level, A-weighted	Octave frequency bands [Hz]								LpA 3 m [dBA]	LpA 1 m [dBA]	
	Total	63	125	250	500	1000	2000	4000			8000
Centro 250 L											
LWA to inlet [dBA]	89	53	76	74	78	84	85	80	70	69	79
LWA to outlet [dBA]	89	56	68	78	75	83	86	79	71	68	78
LWA to environment [dBA]	68	36	50	60	63	62	61	56	42	47	57
Centro 250											
LWA to inlet [dBA]	90	61	78	85	83	85	81	77	65	70	80
LWA to outlet [dBA]	88	64	77	73	82	84	82	77	63	68	78
LWA to environment [dBA]	69	35	49	61	64	64	62	50	39	49	59

CENTRO 315

Sound power level, A-weighted	Octave frequency bands [Hz]								LpA 3 m [dBA]	LpA 1 m [dBA]	
	Total	63	125	250	500	1000	2000	4000			8000
Centro 315											
LWA to inlet [dBA]	86	51	73	71	75	81	82	77	68	66	76
LWA to outlet [dBA]	87	55	66	76	73	81	84	77	69	66	76
LWA to environment [dBA]	69	30	48	59	63	65	62	52	38	48	58
Centro 315 max											
LWA to inlet [dBA]	93	56	80	78	82	88	89	84	74	73	83
LWA to outlet [dBA]	93	59	72	82	79	87	90	83	75	72	82
LWA to environment [dBA]	78	33	54	63	71	73	73	63	55	57	67

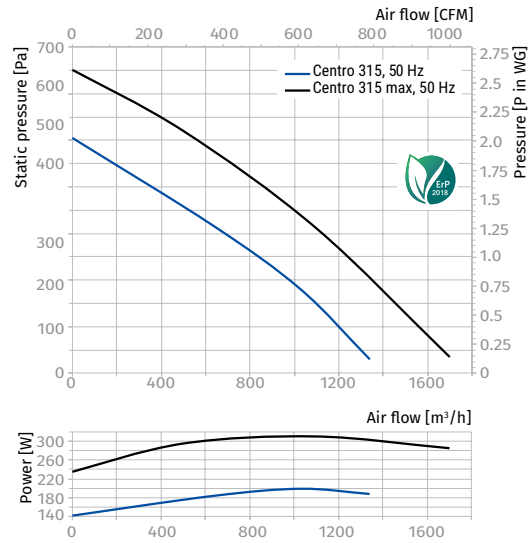
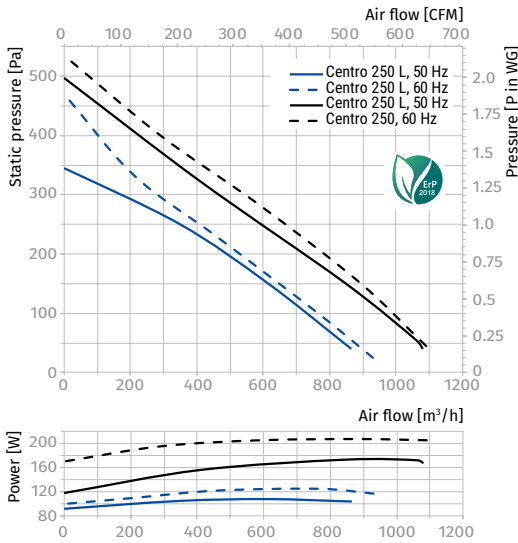

Parameters	Centro 100 V2		Centro 125 V2		Centro 150 V2		Centro 200 V2	
	min	max	min	max	min	max	min	max
Speed								
Voltage [V]	1 ~ 230		1 ~ 230		1 ~ 230		1 ~ 230	
Frequency [Hz]	50		50		50		50	
Power [W]	45	57	45	58	46	59	83	95
Current [A]	0.21	0.25	0.21	0.26	0.22	0.26	0.27	0.43
Maximum air flow [m³/h (l/s)]	157 (44)	264 (73)	191 (53)	329 (91)	264 (73)	445 (124)	430 (119)	741 (206)
RPM [min⁻¹]	1820	2440	1810	2380	1805	2420	1920	2470
Sound pressure at 3 m [dBA]	38		39		40		42	
Transported air temperature [°C]	-25...+55		-25...+55		-25...+55		-25...+55	
SEC class	D		D		D		C	
IP rating	IPX4		IPX4		IPX4		IPX4	
Motor IP rating	IP44		IP44		IP44		IP44	
ErP	2018		2018		2018		2018	

CENTRO 100 V2

Sound power level, A-weighted	Octave frequency bands [Hz]									LpA 3 m [dBA]	LpA 1 m [dBA]
	Total	63	125	250	500	1000	2000	4000	8000		
LWA to inlet [dBA]	79	57	71	77	69	64	60	54	43	58	68
LWA to outlet [dBA]	79	64	72	77	69	61	57	53	42	58	68
LWA to environment [dBA]	58	27	46	48	53	54	50	41	32	38	48

CENTRO 125 V2

Sound power level, A-weighted	Octave frequency bands [Hz]									LpA 3 m [dBA]	LpA 1 m [dBA]
	Total	63	125	250	500	1000	2000	4000	8000		
LWA to inlet [dBA]	81	59	74	79	72	66	62	56	45	61	71
LWA to outlet [dBA]	79	64	72	77	69	61	58	53	42	58	68
LWA to environment [dBA]	59	27	48	49	53	55	51	43	33	39	49

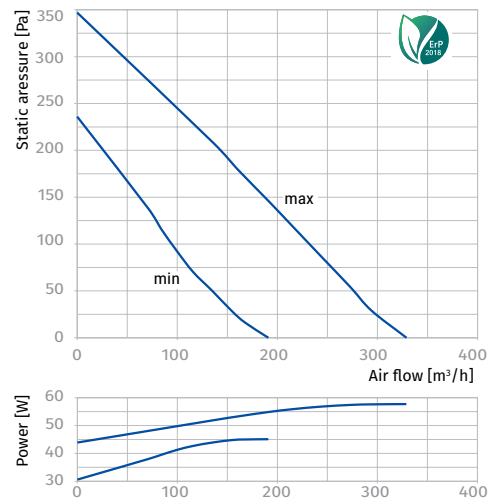
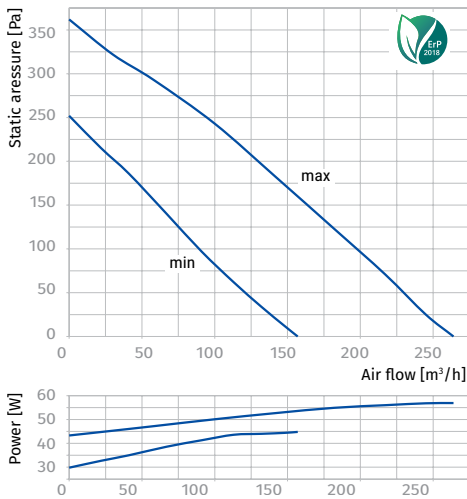

CENTRO 150 V2

Sound power level, A-weighted	Octave frequency bands [Hz]									LpA 3 m [dBA]	LpA 1 m [dBA]
	Total	63	125	250	500	1000	2000	4000	8000		
LWA to inlet [dBA]	88	52	85	84	74	73	70	67	53	67	77
LWA to outlet [dBA]	86	51	84	82	69	68	63	62	50	66	76
LWA to environment [dBA]	61	25	45	53	55	55	55	46	34	40	50

CENTRO 200 V2

Sound power level, A-weighted	Octave frequency bands [Hz]									LpA 3 m [dBA]	LpA 1 m [dBA]
	Total	63	125	250	500	1000	2000	4000	8000		
LWA to inlet [dBA]	81	45	70	77	73	73	74	67	56	61	71
LWA to outlet [dBA]	79	41	69	72	71	71	73	66	56	58	68
LWA to environment [dBA]	62	25	45	55	57	57	55	48	37	42	52

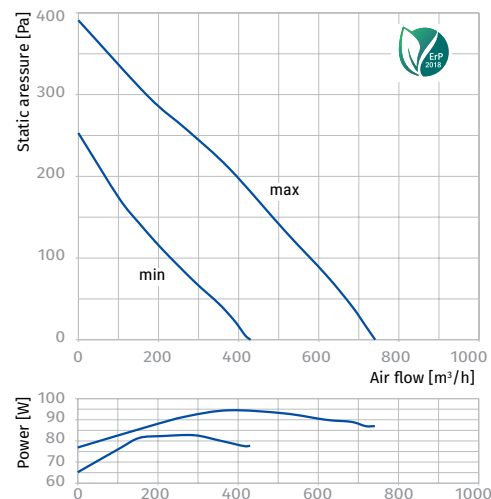
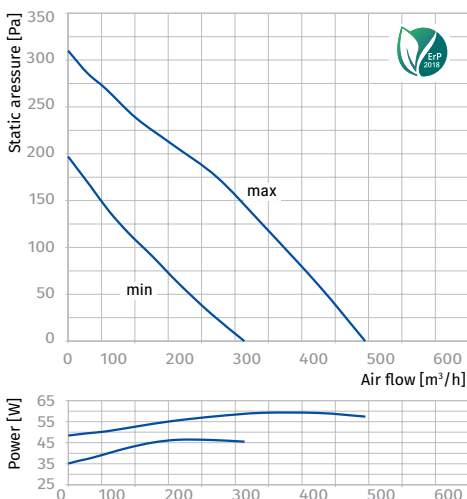

Parameters	Centro 250 V2		Centro 315 V2	
Speed	min	max	min	max
Voltage [V]	1 ~ 230		1 ~ 230	
Frequency [Hz]	50		50	
Power [W]	147	176	143	173
Current [A]	0.66	0.76	0.68	0.76
Maximum air flow [m ³ /h (l/s)]	642 (178)	1126 (313)	758 (211)	1268 (352)
RPM [min ⁻¹]	1940	2370	1870	2410
Sound pressure at 3 m [dBA]	46		48	
Transported air temperature [°C]	-25...+55		-25...+55	
SEC class	C		-	
IP rating	IPX4		IPX4	
Motor IP rating	IP44		IP44	
ErP	2018		-	

CENTRO 250 V2

Sound power level, A-weighted	Octave frequency bands [Hz]									LpA 3 m [dBA]	LpA 1 m [dBA]
	Total	63	125	250	500	1000	2000	4000	8000		
LWA to inlet [dBA]	86	51	73	71	75	81	82	77	67	66	76
LWA to outlet [dBA]	87	54	66	76	73	81	83	77	69	66	76
LWA to environment [dBA]	67	35	49	59	62	61	60	55	41	46	56

CENTRO 315 V2

Sound power level, A-weighted	Octave frequency bands [Hz]									LpA 3 m [dBA]	LpA 1 m [dBA]
	Total	63	125	250	500	1000	2000	4000	8000		
LWA to inlet [dBA]	90	54	77	75	79	85	86	81	71	70	80
LWA to outlet [dBA]	89	56	68	78	75	83	86	79	71	68	78
LWA to environment [dBA]	69	37	51	61	64	63	62	57	43	48	58

